

## Bari

Encimera · Plan de vasque · Top · Waschtischplatte mit integriertem waschbecken

ES · FR · EN · IT · DE



La encimera Bari busca la simplicidad en sus formas sin prescindir de la funcionalidad requerida en este tipo de espacios, una encimera práctica y sencilla que no necesita más que ella misma.

Le plan de vasque Bari recherche la simplicité dans ses formes sans se priver de la fonctionnalité requise dans ce type d'espaces, un plan de vasque simple et pratique qui se suffit à lui-même.

The Bari top exudes simplicity while delivering the high functionality required for its use, a practical and simple top that is self-sufficient.

Il top Bari cerca la semplicità nelle sue forme senza rinunciare alla funzionalità necessaria in questo tipo di spazi, un top pratico e semplice che basta a se stesso.

Die Waschtischplatte Bari mit integriertem Waschbecken sucht in ihren Formen die Schlichtheit, ohne hierbei auf die für diese Art von Räumen erforderliche Zweckmäßigkeit zu verzichten. Eine praktische und schlichte Platte, die alleine völlig ausreicht.

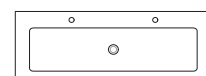
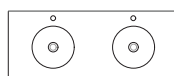
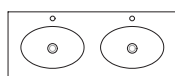
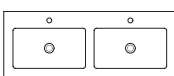
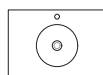
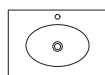
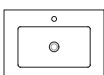

Seno Estándar  
Vasque Estándar  
Estándar washbasin  
Lavabo Estándar  
Becken Estándar

P. 3

Seno Oval  
Vasque Oval  
Oval washbasin  
Lavabo Oval  
Becken Oval

P. 5

Seno Circular  
Vasque Circular  
Circular washbasin  
Lavabo Circular  
Becken Circular

P. 7

Seno Mini  
Vasque Mini  
Mini washbasin  
Lavabo Mini  
Becken Mini

P. 9

Seno XL85-XL 120  
Vasque XL85-XL 120  
XL85-XL 120 washbasin  
Lavabo XL85-XL 120  
Becken XL85-XL 120

P. 11

## Bari

**ACABADOS :**  
**FINITIONS :**  
**FINISHES :**  
**FINITURE :**  
**FINISH-OPTIONEN :**
*Textura · Texture · Texture · Tessitura · Textur*

Solid Surface

*Colores · Coloris · Colours · Colori · Farben*

Standard



S-Blanco

**VÁLVULAS :**
**BONDES :**  
**DRAINS :**  
**SIFONI :**  
**ABLAUF :**

RESIGRES

Ø 750



1" 1/4

Válvula click solid  
 Bonde click solid  
 Solid click drain  
 Piletta click solid  
 Solid Klick-Ablauf

**MATERIAL :**  
**MATÉRIAL :**  
**MATERIALE :**  
**MATERIALE :**
**Akrytan®-Solid**

Akrytan®-Solid es un material uniforme formado por una resina compacta de base acrílica complementada con pigmentos y cargas minerales de altas prestaciones. También llamada de forma habitual Solid Surface este material destaca por la suavidad de su tacto además de por sus propiedades mecánicas, químicas, higiénicas y de fácil reparación. Es el material ideal para utilizar en los proyectos arquitectónicos más exigentes.

**Propiedades:**

Antideslizante.  
 Antibacterias.  
 Todo masa.  
 Personalizable.  
 No hidrólisis.  
 Fácil limpieza.  
 Dureza y baja fragilidad.  
 Reparable.  
 Ligero.  
 Resistencia UV.

**Akrytan®-Solid**

Akrytan®-Solid est un matériel uniforme formé d'une résine compacte avec une base en acrylique complémentée de pigments et de charges minérales de haute qualité. Ce matériel, qu'on appelle habituellement Solid Surface, se démarque grâce à sa douceur au toucher mais également à ses propriétés mécaniques, chimiques, hygiéniques et sa facilité à être réparé. Il est idéal pour les projets architecturaux les plus exigeants.

**Propriétés:**

Antiglisse.  
 Antibactérien.  
 Toute la même masse.  
 Personnalisable.  
 Sans hydrolyse.  
 Entretien facile.  
 Grande dureté et léger.  
 Réparable.  
 Faible fragilité.  
 Résistance aux UV.

**Akrytan®-Solid**

Akrytan®-Solid is a uniform material made up of a compact acrylic-based resin complemented with high-performance pigments and mineral fillers. Also commonly known as Solid Surface, this material stands out for its soft texture as well as its mechanical, chemical, hygienic and easy-to-repair qualities. It is the ideal material to use in the most demanding architectural projects.

**Properties:**

Anti-slip.  
 Antibacterial.  
 Mass-coloured.  
 Customizable.  
 Hydrolysis-free.  
 Easy to clean.  
 High-strength & light.  
 Repairable.  
 Durable.  
 UV resistance.

**Akrytan®-Solid**

Akrytan®-Solid è un materiale uniforme composto da una resina compatta a base acrilica integrata da pigmenti ad alte prestazioni e cariche minerali. Conosciuto anche come Solid Surface, questo materiale si distingue per la sua morbidezza al tatto e per le sue proprietà meccaniche, chimiche, igieniche e per la facile riparabilità. È il materiale ideale per i progetti architettonici più difficili.

**Caratteristiche:**

Antiscivolo.  
 Antibatterico.  
 Tutto massa.  
 Personalizzabile.  
 Esente da idrolisi.  
 Facile da pulire.  
 Di elevata durezza.  
 Riparabile.  
 Leggero.  
 Bassa fragilità.  
 Resistente ai raggi UV.

**Akrytan®-Solid**

Akrytan®-Solid ist ein einheitliches Material aus einem kompakten Harz auf Acrylbasis mit Hochleistungspigmenten und mineralischen Füllstoffen. Dieses Material wird auch als Solid Surface bezeichnet und zeichnet sich durch seine weiche Textur sowie mechanische, chemische, hygienische und reparaturfreundliche Eigenschaften aus. Es ist das ideale Material für anspruchsvollste Architekturprojekte.

**Eigenschaften:**

Rutschhemmend.  
 Antibakteriell.  
 Massegefärbt.  
 Anpassbare.  
 Keine Hydrolyse.  
 Reinigungsfreundlich.  
 Reparierbar.  
 Robust.  
 UV-beständig.

**NORMATIVAS :**  
**RÈGLES :**  
**REGULATIONS :**  
**NORMATIVE :**  
**ZERTIFIEZIRUNG :**
**UNE EN 14688****Pass**

Aptitud para limpieza - Resistencia a carga - Durabilidad - Rayado y abrasión  
 Aptitude pour le nettoyage - Durabilité - Rayage et abrasion  
 Cleaning suitability - Load resistance - Durability - Scratching and abrasion  
 Idoneità alla pulizia - Resistenza al carico - Durata - Graffi e abrasioni  
 Reinigungseignung - Lastwiderstand - Haltbarkeit - Kratzen und Abrieb



**Bari**

**COPETES**  
**PLINTHES**  
**BACKSPLASHES**  
**ALZATINE**  
**WANDABSCHLUSSLEISTE**

**Estándar** · Standard

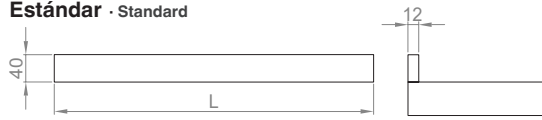

**A medida** · Sur mesure · Custom-made · Su misura · Nach maß

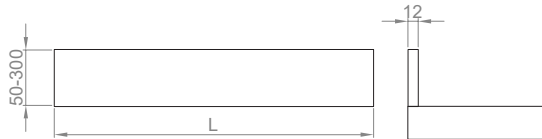

**Estándar integrado recto** · Intégrée droit standard · St. 90° integrated · Standard integrata ad angolo retto · Integrierte gerade standard

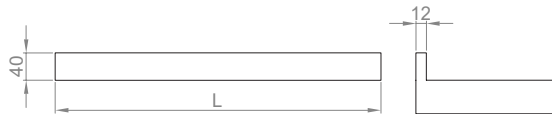

**Estándar integrado curvo** · Intégrée concave standard · St. curved integrated · St. integrata arrotondata · Integrierte kurvig standard

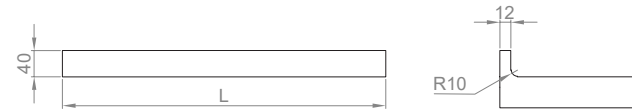

**Integrado recto a medida** · Intégrée droit sur mesure · Custom 90° integ. · Integ. ad angolo retto su misura · Integ. gerade nach maß

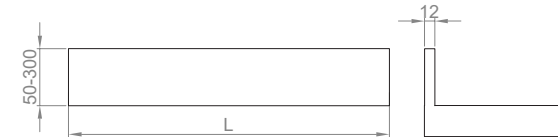

**Integrado curvo a medida** · Intégrée concave sur mesure · Custom curved integ. · Integ. arrotondata su misura · Integ. kurvig nach maß

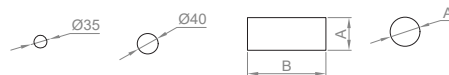
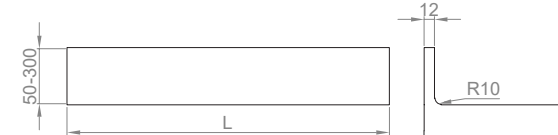

Mecanizados en copete estándar y a medida  
 Découpes sur plinthes standard et sur mesure  
 Standard and custom backsplash holes  
 Fori sulle alzatine standard e su misura  
 Auf der Wandabschlussleiste standard und Nach Maß

**TOALLERO**  
**PORTE-SERVIETTE**  
**TOWEL RACK**  
**PORTASCIUGAMANI**  
**HANDTUCHHALTER**

**Estándar 35** · Standard 35

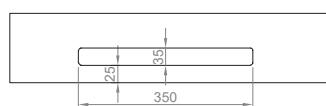

**Estándar 40** · Standard 40



**Mini**

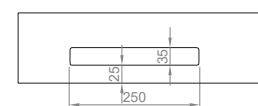

**XL**

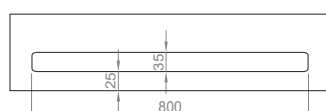

**A medida** · Sur mesure · Custom-made · Su misura · Nach maß

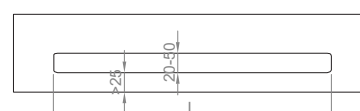

**CORTES Y FALDÓN**  
**DÉCOUPES ET RETOMBÉE**  
**CUTS AND HEIGHT MAX.**  
**TAGLI E ALTEZZA MAX.**  
**SCHNITTE UND VORDERABSCHLUSS**

**Rectos a medida** · Droites · Straights · Diritti · Gerade

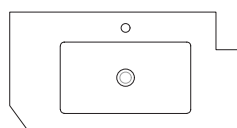

**Faldón XL** · Retombée XL · XL height · Altezza XL · Vorderabschluss XL



**Seno Estándar** · Vasque Estándar · Estándar washbasin · Lavabo Estándar · Becken Estándar

IMÁGEN  
IMAGE  
PICTURE  
IMMAGINE  
BILD



DIMENSIONES  
DIMENSIONS  
DIMENSIONS  
DIMENSIONI  
GRÖßE

**Seno · Vasque · Washbasin · Lavabo · Becken**

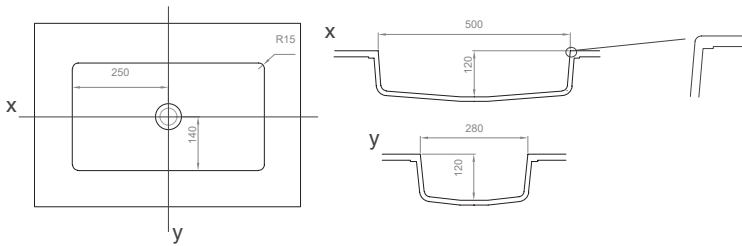

**Encimera · Plan de vasque · Top · Waschtischplatte**

**Un seno · Une vasque · One integrated washbasin · Un lavabo integrado · 1 becken**

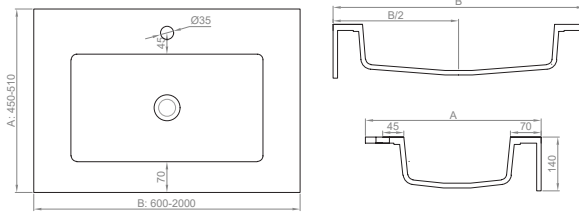

**P = 38,6 kg/m<sup>2</sup>**

Peso por m<sup>2</sup>  
Poids par m<sup>2</sup>  
Weight per m<sup>2</sup>  
Peso per m<sup>2</sup>  
Gewicht pro m<sup>2</sup>

**V = (B+5)x55x20 cm<sup>3</sup>**

Volumen en la caja  
L: largo B: ancho  
Volume dans la boîte  
L: longueur B: largeur

**P\* = 43,6 kg/m<sup>2</sup>**

Peso con embalaje  
Poids avec emballage  
Weight with packaging  
Peso con imballaggio  
Gewicht mit verpackung

Volumen in box  
L: length B: width  
Volume nella scatola  
L: lunghezza B: larghezza  
Volumen in der Box  
L: lang B: breite

Posición del seno personalizable - Position de la vasque personnalisable - Customizable washbasin position - Posizione del lavabo personalizzabile - Becken nach mass verschob

**Dos senos · Deux vasques · Double integrated washbasin · Doppio lavabo integrato · 2 becken**

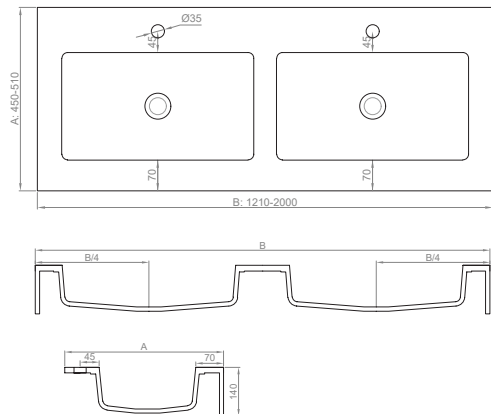

**P = 40,6 kg/m<sup>2</sup>**

Peso por m<sup>2</sup>  
Poids par m<sup>2</sup>  
Weight per m<sup>2</sup>  
Peso per m<sup>2</sup>  
Gewicht pro m<sup>2</sup>

**V = (B+5)x55x20 cm<sup>3</sup>**

Volumen en la caja  
L: largo B: ancho  
Volume dans la boîte  
L: longueur B: largeur

**P\* = 45,6 kg/m<sup>2</sup>**

Peso con embalaje  
Poids avec emballage  
Weight with packaging  
Peso con imballaggio  
Gewicht mit verpackung

Volumen in box  
L: length B: width  
Volume nella scatola  
L: lunghezza B: larghezza  
Volumen in der Box  
L: lang B: breite

Posición de los senos personalizable - Position de la vasque personnalisable - Customizable washbasin position - Posizione dei lavabi personalizzabile - Becken nach mass verschoben

REBOSADERO  
TROP PLEIN  
OVERFLOW  
TROPPIENO  
ÜBERLAUF

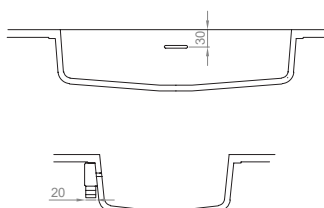

## Seno Estándar · Vasque Estándar · Estándar washbasin · Lavabo Estándar · Becken Estándar

OTROS  
AUTRES  
OTHERS  
ALTRE  
ANDERE

### Distancias mínimas · Distances minimales · Minimum distances · Distanze minime · Mindestabstände

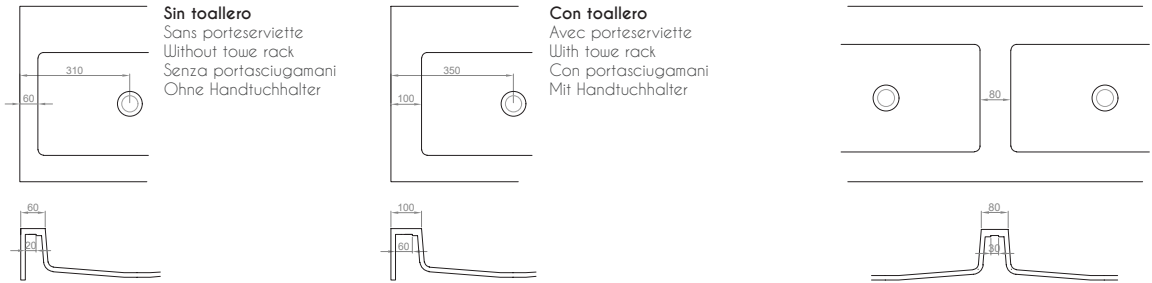

### Tamaños mínimos · Dimensions minimales · Minimum sizes · Dimensione minime · Mindestgrößen

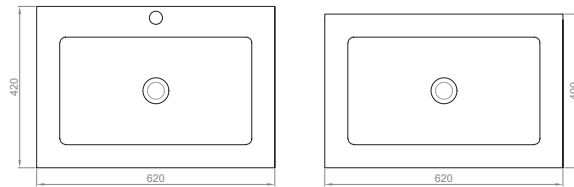

SOPORTES  
SUPPORTS  
WALL ANCHORS  
STAFFE  
WANDHALTERUNGEN

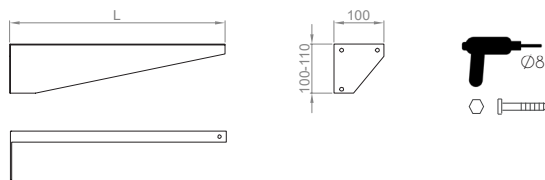

Acero galvanizado lacado  
Acier galvanisé laqué  
Lacquered galvanised steel  
Acciaio zincato laccato  
Lackierter verzinkter Stahl

**Seno Oval** · Vasque Oval · Oval washbasin · Lavabo Oval · Becken Oval

IMÁGEN  
IMAGE  
PICTURE  
IMMAGINE  
BILD



DIMENSIONES  
DIMENSIONS  
DIMENSIONS  
DIMENSIONI  
GRÖßE

**Seno · Vasque · Washbasin · Lavabo · Becken**

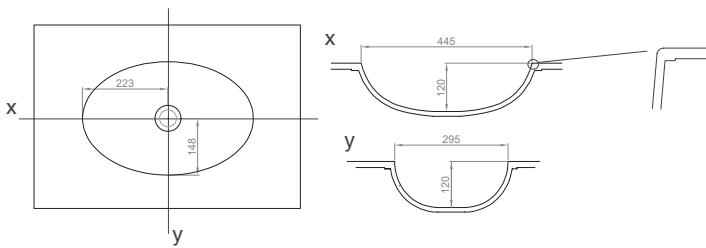

**Encimera · Plan de vasque · Top · Waschtischplatte**

**Un seno · Une vasque · One integrated washbasin · Un lavabo integrato · 1 becken**

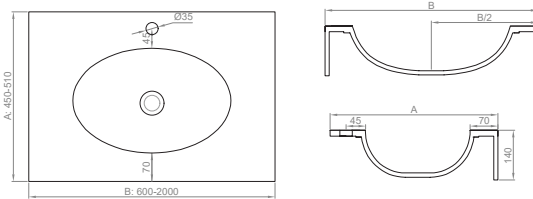

**P = 38,6 kg/m<sup>2</sup>**

Peso por m<sup>2</sup>  
Poids par m<sup>2</sup>  
Weight per m<sup>2</sup>  
Peso per m<sup>2</sup>  
Gewicht pro m<sup>2</sup>

**V = (b+5)x55x20 cm<sup>3</sup>**

Volumen en la caja  
L: largo b: ancho  
Volume dans la boîte  
L: longueur b: largeur

**P\* = 43,6 kg/m<sup>2</sup>**

Peso con embalaje  
Poids avec emballage  
Weight with packaging  
Peso con imballaggio  
Gewicht mit verpackung

Volumen in box  
L: length b: width

Volumen nella scatola  
L: lunghezza b: larghezza

Volumen in der Box  
L: lang b: breiwe

Posición del seno personalizable - Position de la vasque personnalisable - Customizable washbasin position - Posizione del lavabo personalizzabile - Becken nach mass verschob

**Dos senos · Deux vasques · Double integrated washbasin · Doppio lavabo integrato · 2 becken**

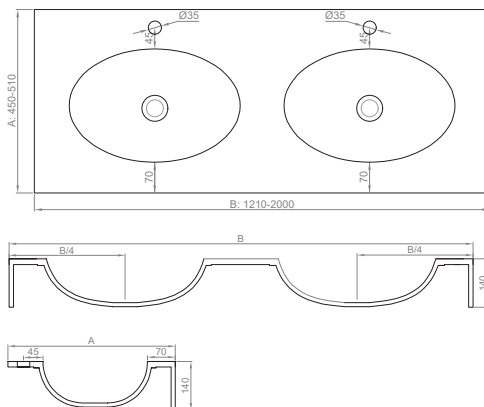

**P = 40,6 kg/m<sup>2</sup>**

Peso por m<sup>2</sup>  
Poids par m<sup>2</sup>  
Weight per m<sup>2</sup>  
Peso per m<sup>2</sup>  
Gewicht pro m<sup>2</sup>

**V = (b+5)x55x20 cm<sup>3</sup>**

Volumen en la caja  
L: largo b: ancho  
Volume dans la boîte  
L: longueur b: largeur

**P\* = 45,6 kg/m<sup>2</sup>**

Peso con embalaje  
Poids avec emballage  
Weight with packaging  
Peso con imballaggio  
Gewicht mit verpackung

Volumen in box  
L: length b: width

Volumen nella scatola  
L: lunghezza b: larghezza

Volumen in der Box  
L: lang b: breiwe

Posición de los senos personalizable - Position de la vasque personnalisable - Customizable washbasin position - Posizione dei lavabi personalizzabile - Becken nach mass verschoben

REBOSADERO  
TROP PLEIN  
OVERFLOW  
TROPPOPIENO  
ÜBERLAUF

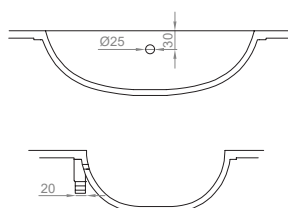

## Seno Oval · Vasque Oval · Oval washbasin · Lavabo Oval · Becken Oval

OTROS  
AUTRES  
OTHERS  
ALTRE  
ANDERE

### Distancias mínimas · Distances minimales · Minimum distances · Distanze minime · Mindestabstände

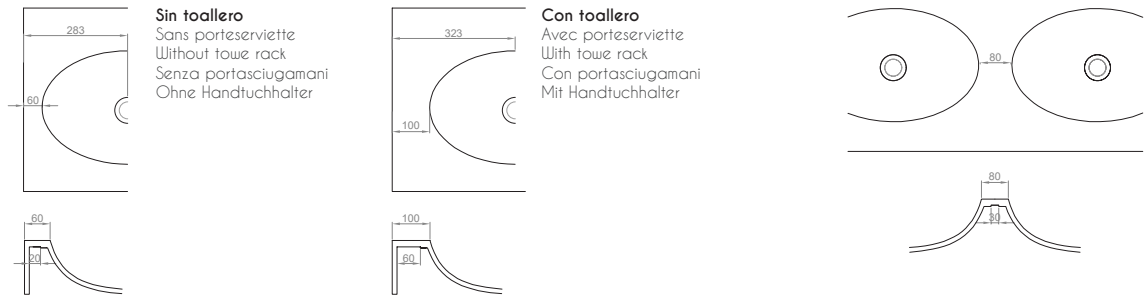

### Tamaños mínimos · Dimensions minimales · Minimum sizes · Dimensione minime · Mindestgrößen

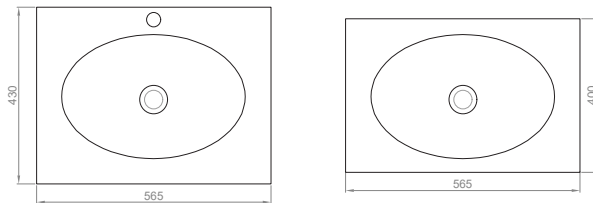

SOPORTES  
SUPPORTS  
WALL ANCHORS  
STAFFE  
WANDHALTERUNGEN

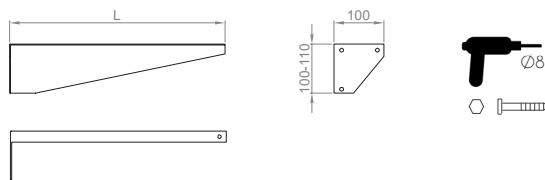

Acero galvanizado lacado  
Acier galvanisé laqué  
Lacquered galvanised steel  
Acciaio zincato laccato  
Lackierter verzinkter Stahl

**Seno Circular** · Vasque Circular · Circular washbasin · Lavabo Circular · Becken Circular

IMÁGEN  
IMAGE  
PICTURE  
IMMAGINE  
BILD

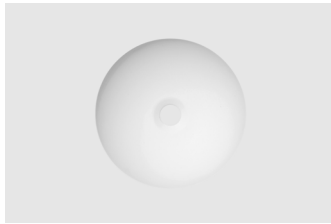

DIMENSIONES  
DIMENSIONS  
DIMENSIONS  
DIMENSIONI  
GRÖßE

**Seno · Vasque · Washbasin · Lavabo · Becken**

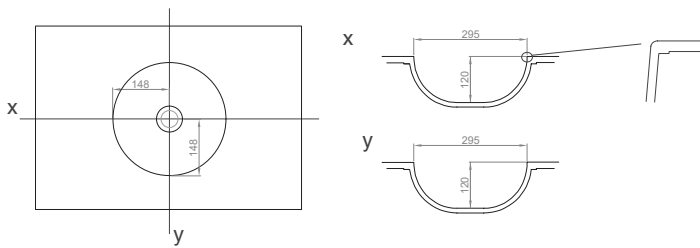

**Encimera · Plan de vasque · Top · Waschtischplatte**

**Un seno · Une vasque · One integrated washbasin · Un lavabo integrato · 1 becken**

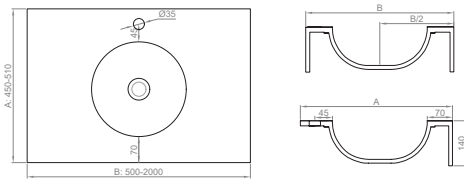

**P = 40,6 kg/m<sup>2</sup>**

Peso por m<sup>2</sup>  
Poids par m<sup>2</sup>  
Weight per m<sup>2</sup>  
Peso per m<sup>2</sup>  
Gewicht pro m<sup>2</sup>

**V = (b+5)x55x20 cm<sup>3</sup>**

Volumen en la caja  
L: largo b: ancho  
Volume dans la boîte  
L: longueur b: largeur

**P\* = 45,6 kg/m<sup>2</sup>**

Peso con embalaje  
Poids avec emballage  
Weight with packaging  
Peso con imballaggio  
Gewicht mit verpackung

Volumen in box  
L: length b: width

Volume nella scatola  
L: lunghezza b: larghezza

Volumen in der Box  
L: lang b: breite

Posición del seno personalizable - Position de la vasque personnalisable - Customizable washbasin position - Posizione del lavabo personalizzabile - Becken nach mass verschob

**Dos senos · Deux vasques · Double integrated washbasin · Doppio lavabo integrato · 2 becken**

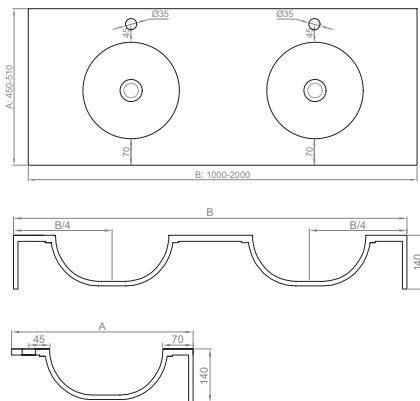

**P = 38,6 kg/m<sup>2</sup>**

Peso por m<sup>2</sup>  
Poids par m<sup>2</sup>  
Weight per m<sup>2</sup>  
Peso per m<sup>2</sup>  
Gewicht pro m<sup>2</sup>

**V = (b+5)x55x20 cm<sup>3</sup>**

Volumen en la caja  
L: largo b: ancho  
Volume dans la boîte  
L: longueur b: largeur

**P\* = 43,6 kg/m<sup>2</sup>**

Peso con embalaje  
Poids avec emballage  
Weight with packaging  
Peso con imballaggio  
Gewicht mit verpackung

Volumen in box  
L: length b: width

Volume nella scatola  
L: lunghezza b: larghezza

Volumen in der Box  
L: lang b: breite

Posición de los senos personalizable - Position de la vasque personnalisable - Customizable washbasin position - Posizione dei lavabi personalizzabile - Becken nach mass verschoben

REBOSADERO  
TROP PLEIN  
OVERFLOW  
TROPPOPIENO  
ÜBERLAUF

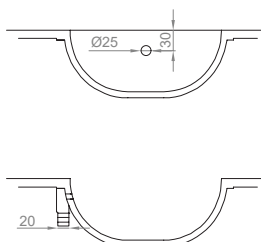



**Seno Circular** · Vasque Circular · Circular washbasin · Lavabo Circular · Becken Circular

OTROS  
AUTRES  
OTHERS  
ALTRE  
ANDERE

**Distancias mínimas** · Distances minimales · Minimum distances · Distanze minime · Mindestabstände

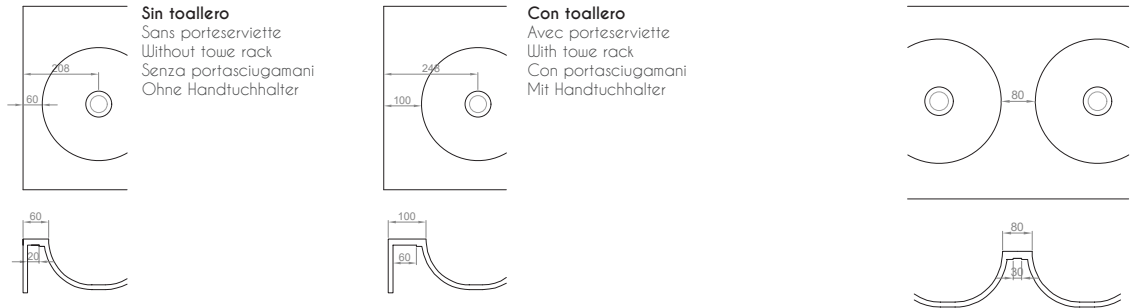

**Tamaños mínimos** · Dimensions minimales · Minimum sizes · Dimensione minime · Mindestgrößen

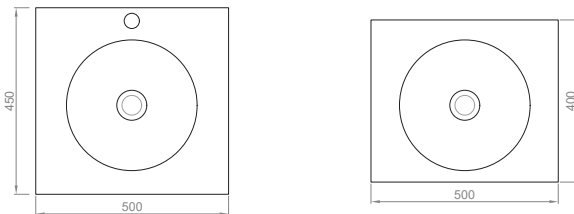

SOPORTES  
SUPPORTS  
WALL ANCHORS  
STAFFE  
WANDHALTERUNGEN

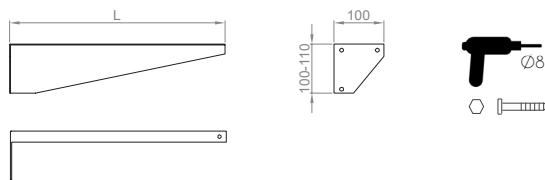

Acero galvanizado lacado  
Acier galvanisé laqué  
Lacquered galvanised steel  
Acciaio zincato laccato  
Lackierter verzinkter Stahl

**Seno Mini** · Vasque Mini · Mini washbasin · Lavabo Mini · Becken Mini

IMÁGEN  
IMAGE  
PICTURE  
IMMAGINE  
BILD



DIMENSIONES  
DIMENSIONS  
DIMENSIONS  
DIMENSIONI  
GRÖßE

**Seno · Vasque · Washbasin · Lavabo · Becken**

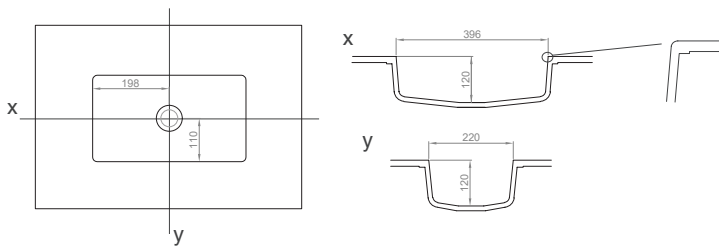

**Encimera · Plan de vasque · Top · Waschtischplatte**

**Central · Centrale · Zentrale**

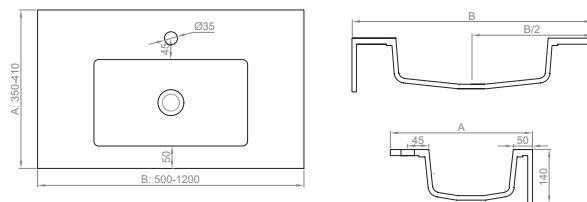

**P = 36,6 kg/m<sup>2</sup>**

Peso por m<sup>2</sup>  
Poids par m<sup>2</sup>  
Weight per m<sup>2</sup>  
Peso per m<sup>2</sup>  
Gewicht pro m<sup>2</sup>

**V = (B+5)x55x20 cm<sup>3</sup>**

Volumen en la caja  
L: largo B: ancho  
Volume dans la boîte  
L: longueur B: largeur

**P\* = 41,6 kg/m<sup>2</sup>**

Peso con embalaje  
Poids avec emballage  
Weight with packaging  
Peso con imballaggio  
Gewicht mit verpackung

Volumen in box  
L: length B: width

Volumen nella scatola  
L: lunghezza B: larghezza

Volumen in der Box  
L: lang B: breite

**Lateral · Latéral · Laterale · Seitlich**

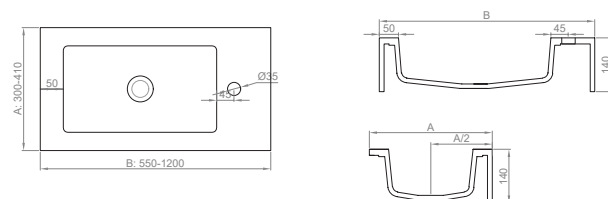

Posición de los senos personalizable - Position de la vasque personnalisable - Customizable washbasin position - Posizione dei lavabi personalizzabile - Becken nach mass verschoben

REBOSADERO  
TROP PLEIN  
OVERFLOW  
TROPPOPIENO  
ÜBERLAUF

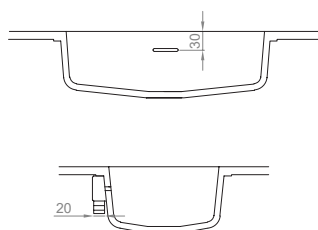

**Seno Mini** · Vasque Mini · Mini washbasin · Lavabo Mini · Becken Mini

OTROS  
AUTRES  
OTHERS  
ALTRE  
ANDERE

**Distancias mínimas** · Distances minimales · Minimum distances · Distanze minime · Mindestabstände

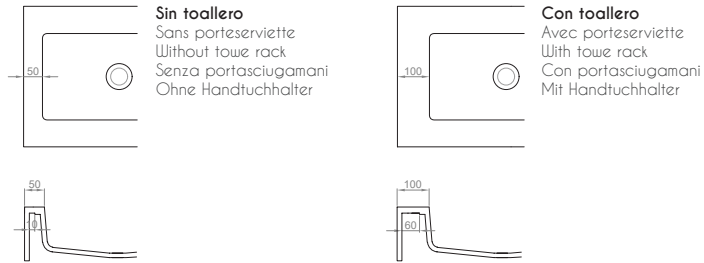

**Tamaños mínimos** · Dimensions minimales · Minimum sizes · Dimensione minime · Mindestgrößen

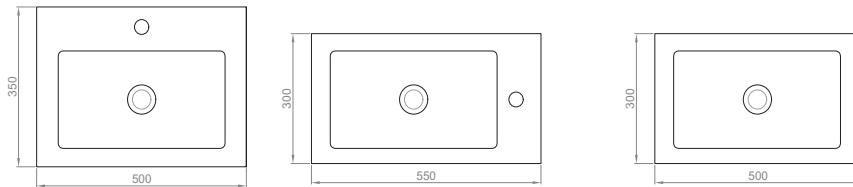

SOPORTES  
SUPPORTS  
WALL ANCHORS  
STAFFE  
WANDHALTERUNGEN

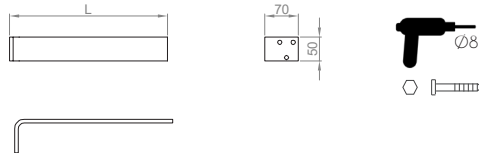

Hierro lacado  
Fer laqué  
Lacquered iron  
Ferro laccato  
Lackiertes Eisen

**Seno XL85** · Vasque XL85 · XL85 washbasin · Lavabo XL85 · Becken XL85

IMÁGEN  
IMAGE  
PICTURE  
IMMAGINE  
BILD



DIMENSIONES  
DIMENSIONS  
DIMENSIONS  
DIMENSIONI  
GRÖßE

**Seno · Vasque · Washbasin · Lavabo · Becken**

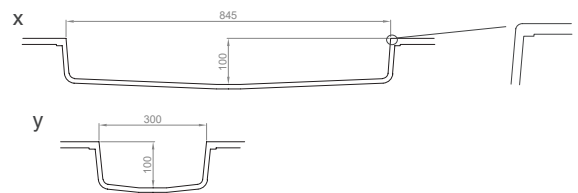
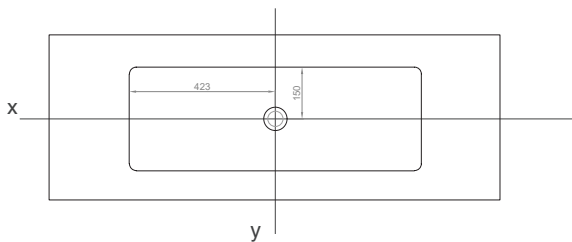

**Encimera · Plan de vasque · Top · Waschtischplatte**

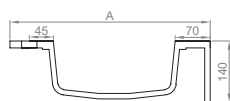
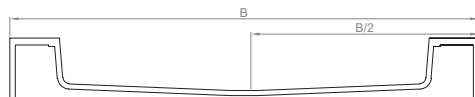
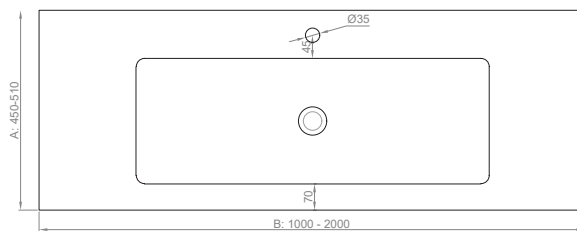

**P = 42,6 kg/m<sup>2</sup>**

Peso por m<sup>2</sup>  
Poids par m<sup>2</sup>  
Weight per m<sup>2</sup>  
Peso per m<sup>2</sup>  
Gewicht pro m<sup>2</sup>

**V = (B+5)x55x20 cm<sup>3</sup>**

Volumen en la caja  
L: largo B: ancho  
Volume dans la boîte  
L: longueur B: largeur

**P\* = 47,6 kg/m<sup>2</sup>**

Peso con embalaje  
Poids avec emballage  
Weight with packaging  
Peso con imballaggio  
Gewicht mit verpackung

Volumen in box  
L: length B: width

Volumen nella scatola  
L: lunghezza B: larghezza

Volumen in der Box  
L: lang B: breite

Posición del seno personalizable - Position de la vasque personnalisable - Customizable washbasin position - Posizione dei lavabi personalizzabile - Becken nach mass verschoben

REBOSADERO  
TROP PLEIN  
OVERFLOW  
TROPPOPIENO  
ÜBERLAUF

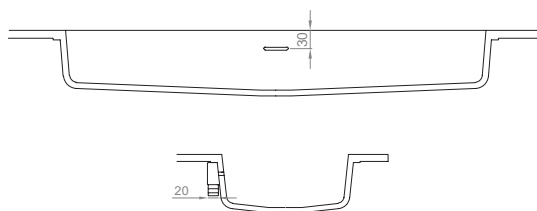

**Seno XL85** · Vasque XL85 · XL85 washbasin · Lavabo XL85 · Becken XL85

OTROS  
AUTRES  
OTHERS  
ALTRE  
ANDERE

**Distancias mínimas** · Distances minimales · Minimum distances · Distanze minime · Mindestabstände

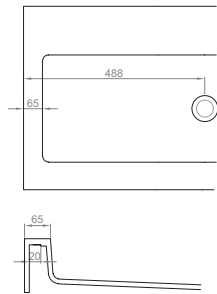

**Sin toallero**  
Sans porteserviette  
Without towel rack  
Senza portasciugamani  
Ohne Handtuchhalter

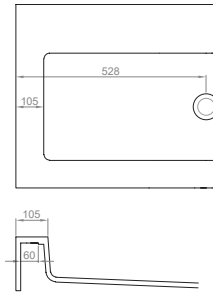

**Con toallero**  
Avec porteserviette  
With towel rack  
Con portasciugamani  
Mit Handtuchhalter

**Tamaños mínimos** · Dimensions minimales · Minimum sizes · Dimensione minime · Mindestgrößen

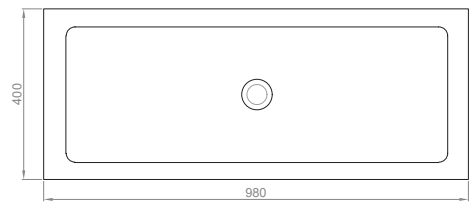
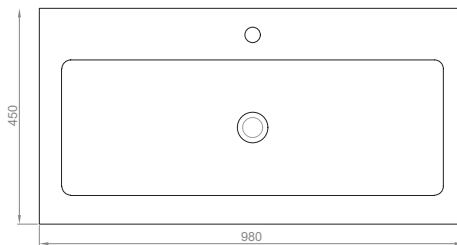

SOPORTES  
SUPPORTS  
WALL ANCHORS  
STAFFE  
WANDHALTERUNGEN

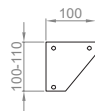
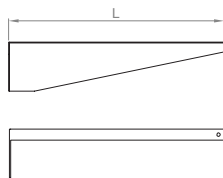

Acero galvanizado lacado  
Acier galvanisé laqué  
Lacquered galvanised steel  
Acciaio zincato laccato  
Lackierter verzinkter Stahl

**Seno XL120** · Vasque XL120 · XL120 washbasin · Lavabo XL120 · Becken XL120

IMÁGEN  
IMAGE  
PICTURE  
IMMAGINE  
BILD

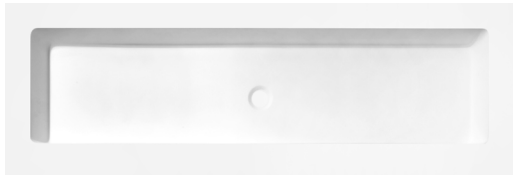

DIMENSIONES  
DIMENSIONS  
DIMENSIONS  
DIMENSIONI  
GRÖßE

**Seno · Vasque · Washbasin · Lavabo · Becken**

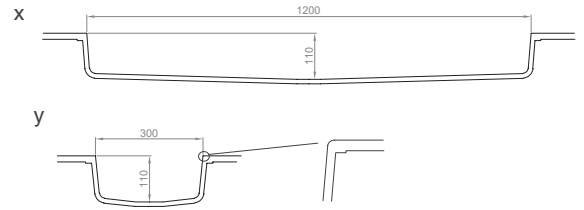
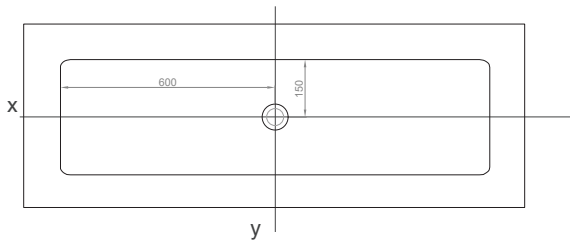

**Encimera · Plan de vasque · Top · Waschtischplatte**

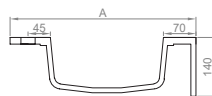
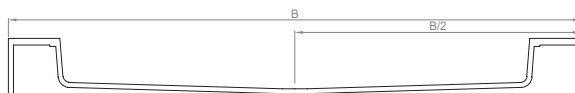
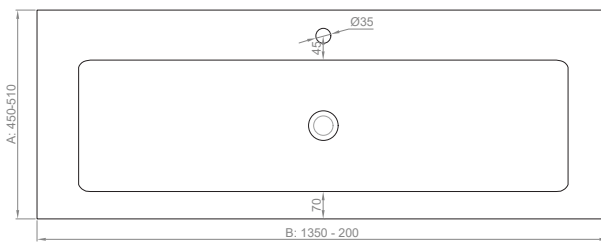

**P = 44,6 kg/m<sup>2</sup>**

Peso por m<sup>2</sup>  
Poids par m<sup>2</sup>  
Weight per m<sup>2</sup>  
Peso per m<sup>2</sup>  
Gewicht pro m<sup>2</sup>

**V = (B+5)x55x20 cm<sup>3</sup>**

Volumen en la caja  
L: largo B: ancho  
Volume dans la boîte  
L: longueur B: largeur

**P\* = 49,6 kg/m<sup>2</sup>**

Peso con embalaje  
Poids avec emballage  
Weight with packaging  
Peso con imballaggio  
Gewicht mit verpackung

Volumen in box  
L: length B: width

Volumen nella scatola  
L: lunghezza B: larghezza  
Volumen in der Box  
L: lang B: breitew

Posición del seno personalizable - Position de la vasque personnalisable - Customizable washbasin position - Posizione dei lavabi personalizzabile - Becken nach mass verschoben

REBOSADERO  
TROP PLEIN  
OVERFLOW  
TROPPOPIENO  
ÜBERLAUF

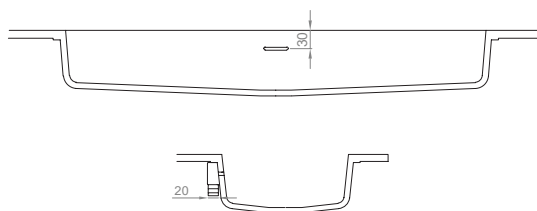

**Seno XL120** · Vasque XL120 · XL120 washbasin · Lavabo XL120 · Becken XL120

OTROS  
AUTRES  
OTHERS  
ALTRE  
ANDERE

**Distancias mínimas** · Distances minimales · Minimum distances · Distanze minime · Mindestabstände

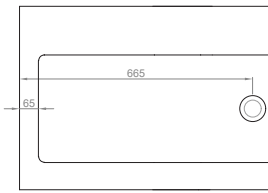

**Sin toallero**  
Sans porteserviette  
Without towel rack  
Senza portasciugamani  
Ohne Handtuchhalter

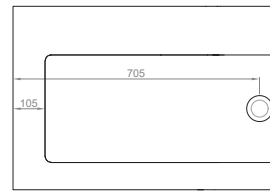

**Con toallero**  
Avec porteserviette  
With towel rack  
Con portasciugamani  
Mit Handtuchhalter



**Tamaños mínimos** · Dimensions minimales · Minimum sizes · Dimensione minime · Mindestgrößen

SOPORTES  
SUPPORTS  
WALL ANCHORS  
STAFFE  
WANDHALTERUNGEN

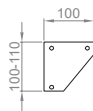
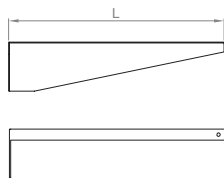

Acero galvanizado lacado  
Acier galvanisé laqué  
Lacquered galvanised steel  
Acciaio zincato laccato  
Lackierter verzinkter Stahl