

Atenea Lisa

Encimera · Plan de vasque · Top · Waschtischplatte mit integriertem waschbecken

ES·FR·EN·IT·DE



La encimera Atenea Lisa busca la simplicidad en sus formas sin prescindir de la funcionalidad requerida en este tipo de espacios, una encimera práctica y sencilla que no necesita más que ella misma.

Le plan de vasque Atenea Lisa recherche la simplicité dans ses formes sans se priver de la fonctionnalité requise dans ce type d'espaces, un plan de vasque simple et pratique qui se suffit à lui-même.

The Atenea Lisa top exudes simplicity while delivering the high functionality required for its use, a practical and simple top that is self-sufficient.

Il top Atenea Lisa cerca la semplicità nelle sue forme senza rinunciare alla funzionalità necessaria in questo tipo di spazi, un top pratico e semplice che basta a se stesso.

Die Waschtischplatte Atenea Lisa mit integriertem Waschbecken sucht in ihren Formen die Schlichtheit, ohne hierbei auf die für diese Art von Räumen erforderliche Zweckmäßigkeit zu verzichten. Eine praktische und schlichte Platte, die alleine völlig ausreicht.

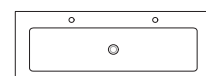
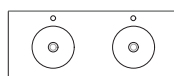
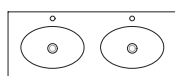
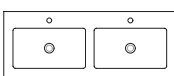
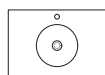
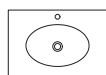
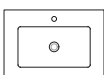

Seno Estándar
Vasque Estándar
Estándar washbasin
Lavabo Estándar
Becken Estándar

P. 3

Seno Oval
Vasque Oval
Oval washbasin
Lavabo Oval
Becken Oval

P. 5

Seno Circular
Vasque Circular
Circular washbasin
Lavabo Circular
Becken Circular

P. 7

Seno Mini
Vasque Mini
Mini washbasin
Lavabo Mini
Becken Mini

P. 9

Seno XL85-XL 120
Vasque XL85-XL 120
XL85-XL 120 washbasin
Lavabo XL85-XL 120
Becken XL85-XL 120

P. 11

Atenea Lisa

ACABADOS
FINITIONS
FINISHES
FINITURE
FINISH-OPTIONEN

Textura · Texture · Texture · Tessitura · Textur

Lisa



Colores · Coloris · Colours · Colori · Farben

Standard



Ártico



Antracita



Negro



Piedra



Gris 7015



Lino



Basalto



Arena



Moka

RAL/NCS

VÁLVULAS
BONDES
DRAINS
SIFONI
ABLAUF

RESI GRES

Ø 750



1" 1/4

Válvula click coloreada
Bonde click colorée
Colored click drain
Piletta click colorata
Farbiger Klick-Ablauf

MATERIAL
MATÉRIAL
MATERIALE
MATERIALE
MATERIAL**Akrytan®**

Akrytan® es un material compuesto por un núcleo de resina coloreada* mezclada con cargas minerales y un acabado superficial con propiedades sanitarias de elevada resistencia. La formulación de la resina que compone Akrytan® confiere a los productos mejoras en su fragilidad, carencia del fenómeno de hidrólisis y un peso un 30% menor que los productos fabricados con otras resinas del mercado.

Propiedades:

Antideslizante.
Antibacterias.
Coloreado en masa.
Personalizable.
No hidrólisis.
Fácil limpieza.
Dureza y baja fragilidad.
Reparable.
Ligero.
Resistencia UV.

Akrytan®

Akrytan® est un matériel composé d'un noyau de résine teintée* mélangée avec des charges minérales et une finition superficielle avec des propriétés sanitaires de haute résistance. L'élaboration de la résine qui compose Akrytan confère aux produits des améliorations du point de vue de la fragilité, une carence du phénomène d'hydrolyse et un poids plus léger de 30 % que les produits fabriqués avec des résines du marché.

Propriétés:

Antiglisse.
Antibactérien.
Teinté dans la masse.
Personnalisable.
Sans hydrolyse.
Entretien facile.
Grande dureté et léger.
Réparable.
Faible fragilité.
Résistance aux UV.

Akrytan®

Akrytan® is a material whose core is composed of coloured resin* mixed with mineral fillers. It has a high-strength hygienic surface. The formula for the resin used in Akrytan makes products less fragile, is devoid of hydrolysis and weighs 30% less than products manufactured with other resins on the market.

Properties:

Anti-slip.
Antibacterial.
Mass-coloured.
Customizable.
Hydrolysis-free.
Easy to clean.
High-strength & light.
Repairable.
Durable.
UV resistance.

Akrytan®

Akrytan® è un materiale composto da un'anima di resina colorata* miscelata con cariche minerali e una finitura superficiale ad alta resistenza con proprietà sanitarie. La formulazione della resina che compone Akrytan rende i prodotti meno fragili, evita il fenomeno dell'idrolisi e consente una riduzione del peso del 30% rispetto ai prodotti realizzati con altre resine sul mercato.

Caratteristiche:

Antiscivolo.
Antibatterico.
Colorato nella massa.
Personalizzabile.
Esente da idrolisi.
Facile da pulire.
Di elevata durezza.
Riparabile.
Leggero.
Bassa fragilità.
Resistente ai raggi UV.

Akrytan®

Akrytan® besteht aus einem farbigen Harzkern gemischt mit mineralischen Füllstoffen und einer Oberfläche mit hochresistenten sanitären Eigenschaften. Die Art des Harzes, aus Akrytan® besteht, sorgt im Vergleich mit anderen Harzen nicht nur für mechanische Verbesserungen, sondern verhindert auch Hydrolyseerscheinungen.

Eigenschaften:

Rutschhemmend.
Antibakteriell.
Massegefärbt.
Anpassbar.
Keine Hydrolyse.
Reinigungsfreundlich.
Reparierbar.
Robust.
UV-beständig.

NORMATIVAS
RÈGLES
REGULATIONS
NORMATIVE
ZERTIFIEZIRUNG**UNE EN 14688
Pass**

Aptitud para limpieza - Resistencia a carga - Durabilidad - Rayado y abrasión
Aptitude pour le nettoyage - Durabilité - Rayage et abrasion
Cleaning suitability - Load resistance - Durability - Scratching and abrasion
Idoneità alla pulizia - Resistenza al carico - Durata - Graffi e abrasioni
Reinigungsseignung - Lastwiderstand - Haltbarkeit - Kratzen und Abrieb



(*) La massa interna è colorata di forma approssimativa al acabado superficiale, non identica. Le rayure o rozaduras, sobre todo en colores oscuros, pueden provocar la aparición de polvo y marcas blancas superficiales derivadas del rayado del mineral interno.
(* The colour of the inner mass is close to the surface finish, but not identical. Scratches and scuffs, especially on darker colours, can create dust and white marks on the surface from scratching the internal mineral.
(* Die Farbe der inneren Masse liegt nahe am Oberflächenfinish, ist jedoch nicht identisch. Kratzer und Abnutzungen, besonders bei dunkleren Farben, können Staub und weiße Flecken auf der Oberfläche erzeugen, wenn das innere Mineral zerkratzt wird.

Atenea Lisa

COPETES
PLINTHES
BACKSPLASHES
ALZATINE
WANDABSCHLUSSLEISTE

Estándar · Standard



A medida · Sur mesure · Custom-made · Su misura · Nach Maß

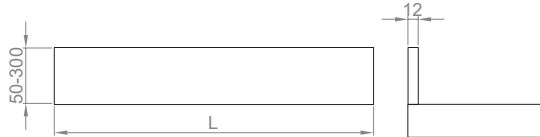

Estándar integrado recto · Intégrée droit standard · St. 90° integrated · Standard integrata ad angolo retto · Integrierte gerade standard

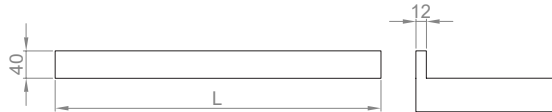

Estándar integrado curvo · Intégrée concave standard · St. curved integrated · St. integrata arrotondata · Integrierte kurvig standard

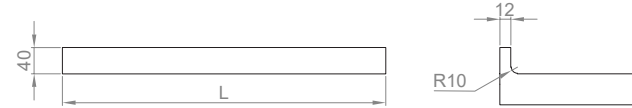

Integrado recto a medida · Intégrée droit sur mesure · Custom 90° integ. · Integ. ad angolo retto su misura · Integ. gerade nach Maß

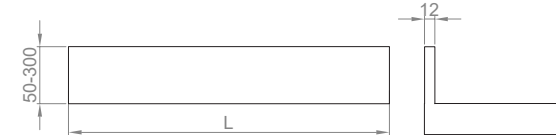

Integrado curvo a medida · Intégrée concave sur mesure · Custom curved integ. · Integ. arrotondata su misura · Integ. kurvig nach Maß

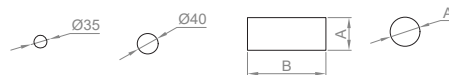
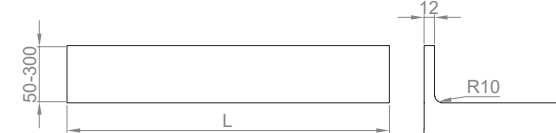

Mecanizados en copete estándar y a medida
 Découpes sur plinthes standard et sur mesure
 Standard and custom backsplash holes
 Fori sulle alzatine standard e su misura
 Auf der Wandabschlussleiste standard und Nach Maß

TOALLERO
PORTE-SERVIETTE
TOWEL RACK
PORTASCIUGAMANI
HANDTUCHHALTER

Estándar 35 · Standard 35

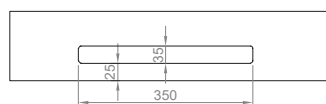

Estándar 40 · Standard 40

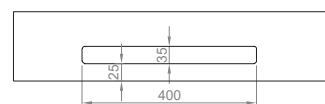

Mini

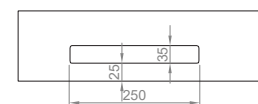

XL



A medida · Sur mesure · Custom-made · Su misura · Nach Maß

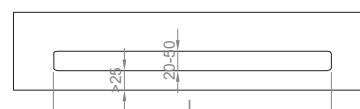

CORTES Y FALDÓN
DÉCOUPES ET RETOMBÉE
CUTS AND HEIGHT MAX.
TAGLI E ALTEZZA MAX.
SCHNITTE UND VORDERABSCHLUSS

Rectos a medida · Droites · Straights · Diritti · Gerade

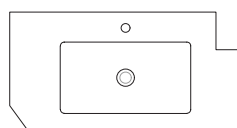

Faldón XL · Retombée XL · XL height · Altezza XL · Vorderabschluss XL



Seno Estándar · Vasque Estándar · Estándar washbasin · Lavabo Estándar · Becken Estándar

IMÁGEN
IMAGE
PICTURE
IMMAGINE
BILD

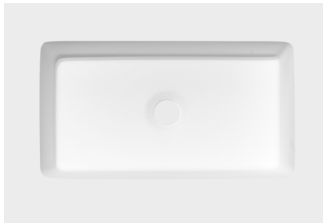

DIMENSIONES
DIMENSIONS
DIMENSIONS
DIMENSIONI
GRÖßE

Seno · Vasque · Washbasin · Lavabo · Becken

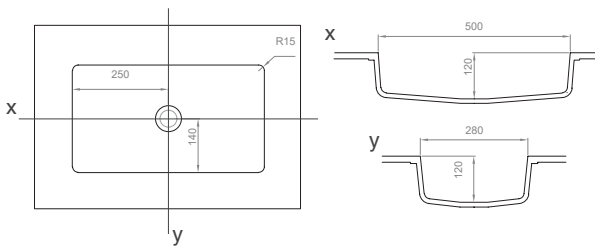

Encimera · Plan de vasque · Top · Waschtischplatte

Un seno · Une vasque · One integrated washbasin · Un lavabo integrado · 1 becken

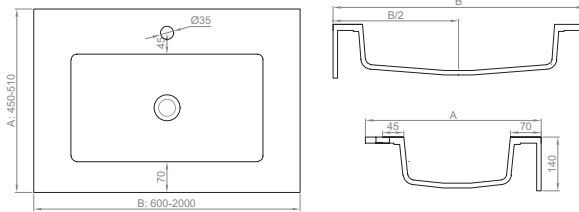

P = 38,6 kg/m²

Peso por m²
Poids par m²
Weight per m²
Peso per m²
Gewicht pro m²

V = (B+5)x55x20 cm³

Volumen en la caja
L: largo B: ancho
Volume dans la boîte
L: longueur B: largeur

P* = 43,6 kg/m²

Peso con embalaje
Poids avec emballage
Weight with packaging
Peso con imballaggio
Gewicht mit verpackung

Volumen in box
L: length B: width
Volume nella scatola
L: lunghezza B: larghezza
Volumen in der Box
L: lang B: breite

Posición del seno personalizable - Position de la vasque personnalisable - Customizable washbasin position - Posizione del lavabo personalizzabile - Becken nach mass verschob

Dos senos · Deux vasques · Double integrated washbasin · Doppio lavabo integrato · 2 becken

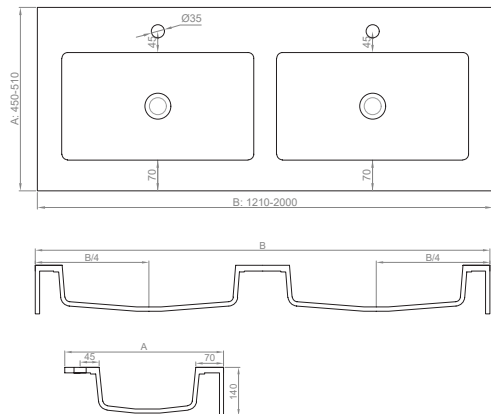

P = 40,6 kg/m²

Peso por m²
Poids par m²
Weight per m²
Peso per m²
Gewicht pro m²

V = (B+5)x55x20 cm³

Volumen en la caja
L: largo B: ancho
Volume dans la boîte
L: longueur B: largeur

P* = 45,6 kg/m²

Peso con embalaje
Poids avec emballage
Weight with packaging
Peso con imballaggio
Gewicht mit verpackung

Volumen in box
L: length B: width
Volume nella scatola
L: lunghezza B: larghezza
Volumen in der Box
L: lang B: breite

Posición de los senos personalizable - Position de la vasque personnalisable - Customizable washbasin position - Posizione dei lavabi personalizzabile - Becken nach mass verschoben

REBOSADERO
TROP PLEIN
OVERFLOW
TROPPOPIENO
ÜBERLAUF

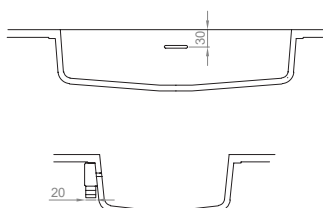

Seno Estándar · Vasque Estándar · Estándar washbasin · Lavabo Estándar · Becken Estándar

OTROS
AUTRES
OTHERS
ALTRE
ANDERE

Distancias mínimas · Distances minimales · Minimum distances · Distanze minime · Mindestabstände

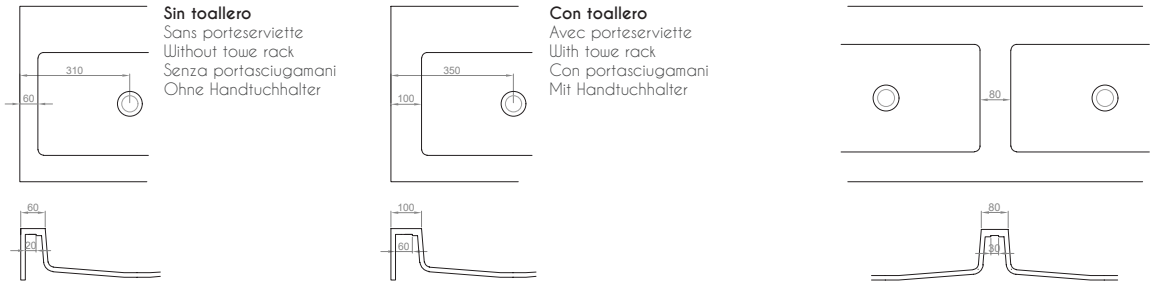

Tamaños mínimos · Dimensions minimales · Minimum sizes · Dimensione minime · Mindestgrößen

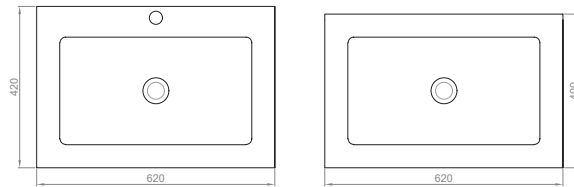

SOPORTES
SUPPORTS
WALL ANCHORS
STAFFE
WANDHALTERUNGEN

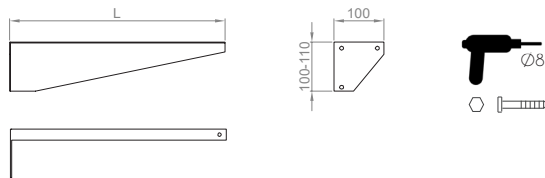

Acero galvanizado lacado
Acier galvanisé laqué
Lacquered galvanised steel
Acciaio zincato laccato
Lackierter verzinkter Stahl

Seno Oval · Vasque Oval · Oval washbasin · Lavabo Oval · Becken Oval

IMÁGEN
IMAGE
PICTURE
IMMAGINE
BILD



DIMENSIONES
DIMENSIONS
DIMENSIONS
DIMENSIONI
GRÖßE

Seno · Vasque · Washbasin · Lavabo · Becken

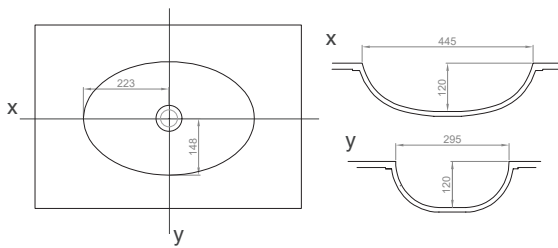

Encimera · Plan de vasque · Top · Waschtischplatte

Un seno · Une vasque · One integrated washbasin · Un lavabo integrato · 1 becken

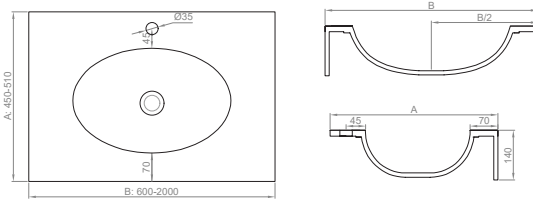

P = 38,6 kg/m²

Peso por m²
Poids par m²
Weight per m²
Peso per m²
Gewicht pro m²

V = (b+5)x55x20 cm³

Volumen en la caja
L: largo b: ancho
Volume dans la boîte
L: longueur b: largeur

P* = 43,6 kg/m²

Peso con embalaje
Poids avec emballage
Weight with packaging
Peso con imballaggio
Gewicht mit verpackung

Volumen in box
L: length b: width

Volumen nella scatola
L: lunghezza b: larghezza

Volumen in der Box
L: lang b: breiwe

Posición del seno personalizable - Position de la vasque personnalisable - Customizable washbasin position - Posizione del lavabo personalizzabile - Becken nach mass verschob

Dos senos · Deux vasques · Double integrated washbasin · Doppio lavabo integrato · 2 becken

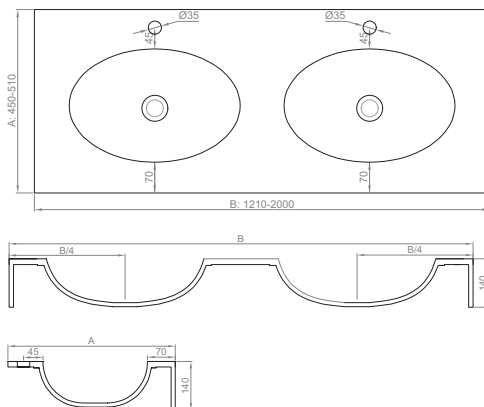

P = 40,6 kg/m²

Peso por m²
Poids par m²
Weight per m²
Peso per m²
Gewicht pro m²

V = (b+5)x55x20 cm³

Volumen en la caja
L: largo b: ancho
Volume dans la boîte
L: longueur b: largeur

P* = 45,6 kg/m²

Peso con embalaje
Poids avec emballage
Weight with packaging
Peso con imballaggio
Gewicht mit verpackung

Volumen in box
L: length b: width

Volumen nella scatola
L: lunghezza b: larghezza

Volumen in der Box
L: lang b: breiwe

Posición de los senos personalizable - Position de la vasque personnalisable - Customizable washbasin position - Posizione dei lavabi personalizzabile - Becken nach mass verschoben

REBOSADERO
TROP PLEIN
OVERFLOW
TROPPOPIENO
ÜBERLAUF

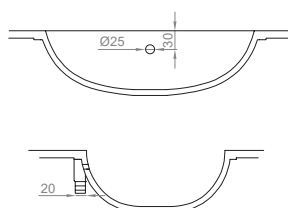

Seno Oval · Vasque Oval · Oval washbasin · Lavabo Oval · Becken Oval

OTROS
AUTRES
OTHERS
ALTRE
ANDERE

Distancias mínimas · Distances minimales · Minimum distances · Distanze minime · Mindestabstände

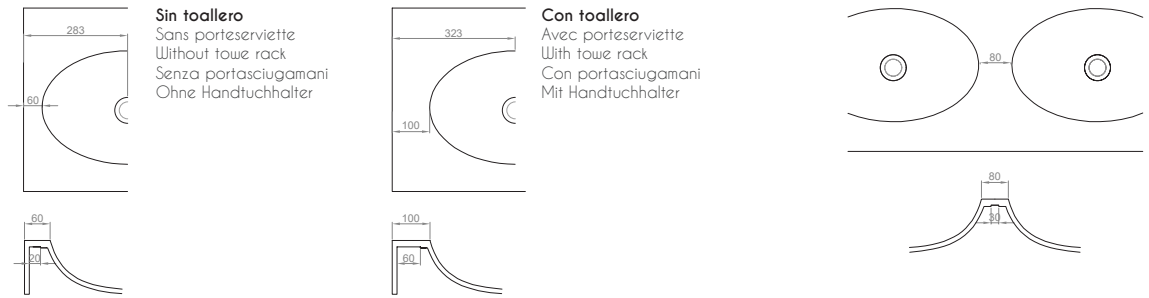

Tamaños mínimos · Dimensions minimales · Minimum sizes · Dimensione minime · Mindestgrößen

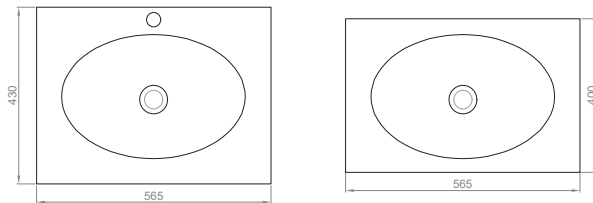

SOPORTES
SUPPORTS
WALL ANCHORS
STAFFE
WANDHALTERUNGEN

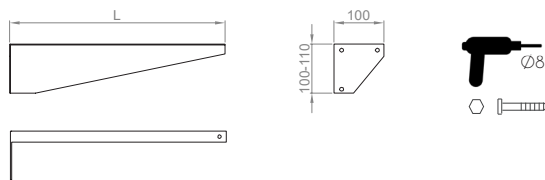

Acero galvanizado lacado
Acier galvanisé laqué
Lacquered galvanised steel
Acciaio zincato laccato
Lackierter verzinkter Stahl

Seno Circular · Vasque Circular · Circular washbasin · Lavabo Circular · Becken Circular

IMÁGEN
IMAGE
PICTURE
IMMAGINE
BILD

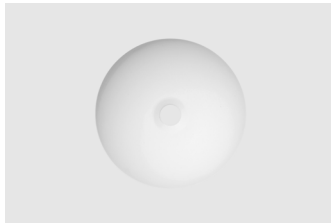

DIMENSIONES
DIMENSIONS
DIMENSIONS
DIMENSIONI
GRÖßE

Seno · Vasque · Washbasin · Lavabo · Becken

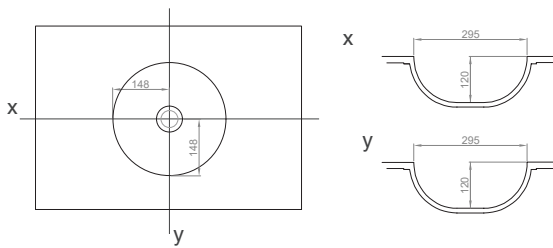

Encimera · Plan de vasque · Top · Waschtischplatte

Un seno · Une vasque · One integrated washbasin · Un lavabo integrato · 1 becken

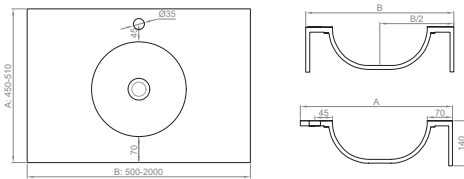

P = 40,6 kg/m²

Peso por m²
Poids par m²
Weight per m²
Peso per m²
Gewicht pro m²

V = (B+5)x55x20 cm³

Volumen en la caja
L: largo B: ancho
Volume dans la boîte
L: longueur B: largeur

P* = 45,6 kg/m²

Peso con embalaje
Poids avec emballage
Weight with packaging
Peso con imballaggio
Gewicht mit verpackung

Volumen in box
L: length B: width
Volume nella scatola
L: lunghezza B: larghezza

Volumen in der Box
L: lang B: breite

Posición del seno personalizable - Position de la vasque personnalisable - Customizable washbasin position - Posizione del lavabo personalizzabile - Becken nach mass verschob

Dos senos · Deux vasques · Double integrated washbasin · Doppio lavabo integrato · 2 becken

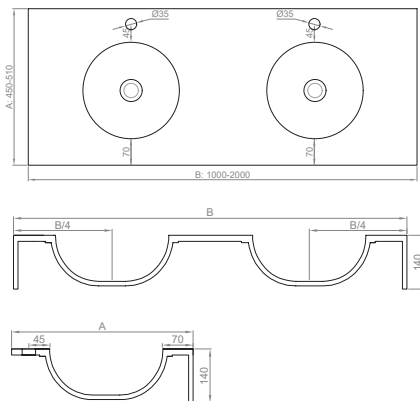

P = 38,6 kg/m²

Peso por m²
Poids par m²
Weight per m²
Peso per m²
Gewicht pro m²

V = (B+5)x55x20 cm³

Volumen en la caja
L: largo B: ancho
Volume dans la boîte
L: longueur B: largeur

P* = 43,6 kg/m²

Peso con embalaje
Poids avec emballage
Weight with packaging
Peso con imballaggio
Gewicht mit verpackung

Volumen in box
L: length B: width
Volume nella scatola
L: lunghezza B: larghezza

Volumen in der Box
L: lang B: breite

Posición de los senos personalizable - Position de la vasque personnalisable - Customizable washbasin position - Posizione dei lavabi personalizzabile - Becken nach mass verschoben

REBOSADERO
TROP PLEIN
OVERFLOW
TROPPOPIENO
ÜBERLAUF

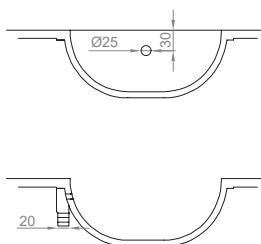

Seno Circular · Vasque Circular · Circular washbasin · Lavabo Circular · Becken Circular

OTROS
AUTRES
OTHERS
ALTRE
ANDERE

Distancias mínimas · Distances minimales · Minimum distances · Distanze minime · Mindestabstände

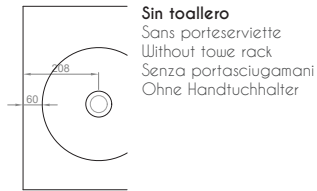

Sin toallero
Sans porteserviette
Without towel rack
Senza portasciugamani
Ohne Handtuchhalter

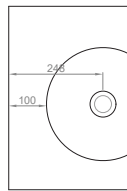

Con toallero
Avec porteserviette
With towel rack
Con portasciugamani
Mit Handtuchhalter

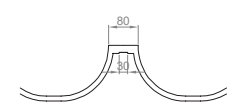
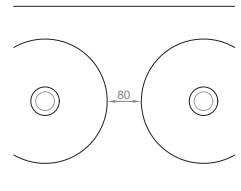
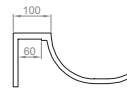
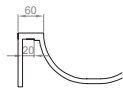

Tamaños mínimos · Dimensions minimales · Minimum sizes · Dimensione minime · Mindestgrößen

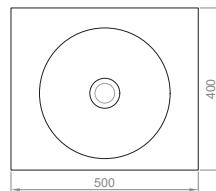
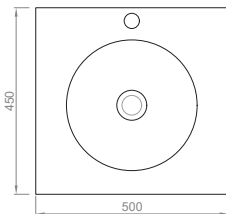

SOPORTES
SUPPORTS
WALL ANCHORS
STAFFE
WANDHALTERUNGEN

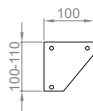
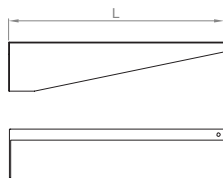

Acero galvanizado lacado
Acier galvanisé laqué
Lacquered galvanised steel
Acciaio zincato laccato
Lackierter verzinkter Stahl

Seno Mini · Vasque Mini · Mini washbasin · Lavabo Mini · Becken Mini

IMÁGEN
IMAGE
PICTURE
IMMAGINE
BILD



DIMENSIONES
DIMENSIONS
DIMENSIONS
DIMENSIONI
GRÖßE

Seno · Vasque · Washbasin · Lavabo · Becken

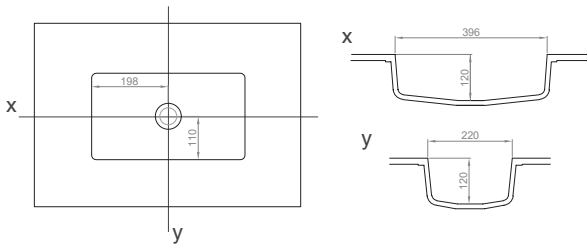

Encimera · Plan de vasque · Top · Waschtischplatte

Central · Centrale · Zentrale

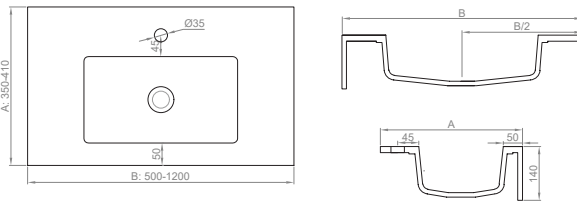

P = 36,6 kg/m²

Peso por m²
Poids par m²
Weight per m²
Peso per m²
Gewicht pro m²

V = (B+5)x55x20 cm³

Volumen en la caja
L: largo B: ancho
Volume dans la boîte
L: longueur B: largeur

P* = 41,6 kg/m²

Peso con embalaje
Poids avec emballage
Weight with packaging
Peso con imballaggio
Gewicht mit verpackung

Volumen in box
L: length B: width

Volumen nella scatola
L: lunghezza B: larghezza

Volumen in der Box
L: lang B: breite

Lateral · Latéral · Laterale · Seitlich

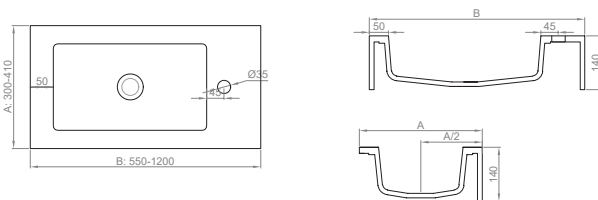

Posición de los senos personalizable - Position de la vasque personnalisable - Customizable washbasin position - Posizione dei lavabi personalizzabile - Becken nach mass verschoben

REBOSADERO
TROP PLEIN
OVERFLOW
TROPPOPIENO
ÜBERLAUF

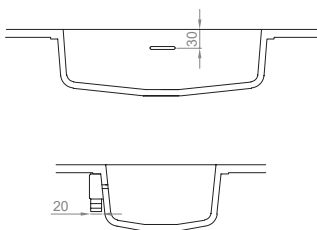

Seno Mini · Vasque Mini · Mini washbasin · Lavabo Mini · Becken Mini

OTROS
AUTRES
OTHERS
ALTRE
ANDERE

Distancias mínimas · Distances minimales · Minimum distances · Distanze minime · Mindestabstände

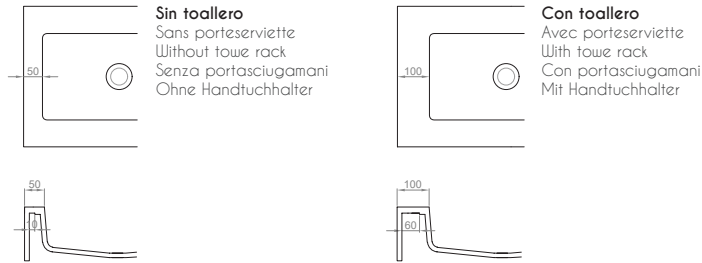

Tamaños mínimos · Dimensions minimales · Minimum sizes · Dimensione minime · Mindestgrößen

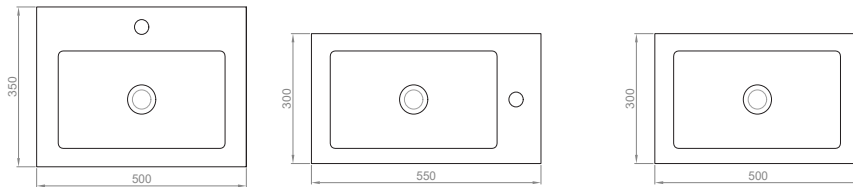

SOPORTES
SUPPORTS
WALL ANCHORS
STAFFE
WANDHALTERUNGEN

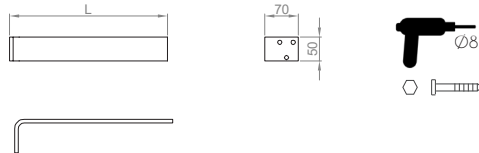

Hierro lacado
Fer laqué
Lacquered iron
Ferro laccato
Lackiertes Eisen

Seno XL85 · Vasque XL85 · XL85 washbasin · Lavabo XL85 · Becken XL85

IMÁGEN
IMAGE
PICTURE
IMMAGINE
BILD

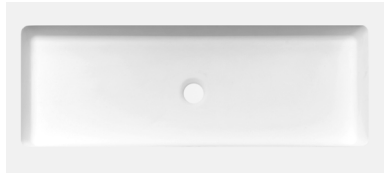

DIMENSIONES
DIMENSIONS
DIMENSIONS
DIMENSIONI
GRÖßE

Seno · Vasque · Washbasin · Lavabo · Becken

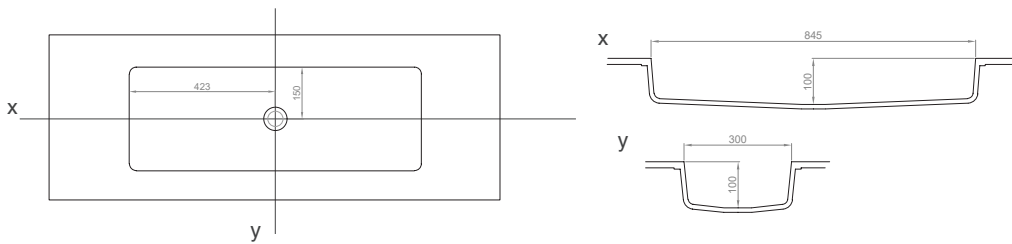

Encimera · Plan de vasque · Top · Waschtischplatte

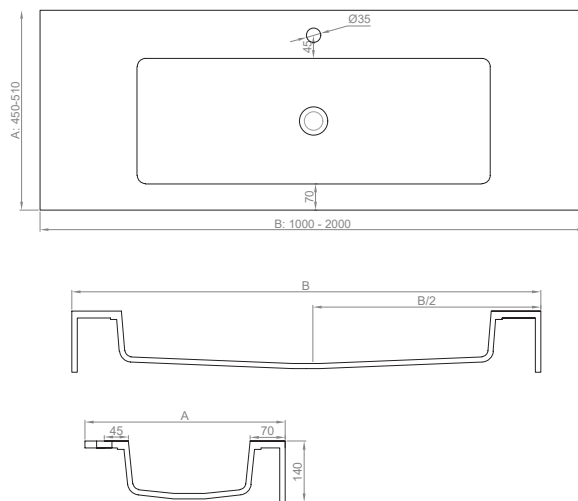

P = 42,6 kg/m²

Peso por m²
Poids par m²
Weight per m²
Peso per m²
Gewicht pro m²

V = (B+5)x55x20 cm³

Volumen en la caja
L: largo B: ancho
Volume dans la boîte
L: longueur B: largeur

P* = 47,6 kg/m²

Peso con embalaje
Poids avec emballage
Weight with packaging
Peso con imballaggio
Gewicht mit verpackung

Volumen in box
L: length B: width

Volumen nella scatola
L: lunghezza B: larghezza

Volumen in der Box
L: lang B: breite

Posición del seno personalizable - Position de la vasque personnalisable - Customizable washbasin position - Posizione dei lavabi personalizzabile - Becken nach mass verschoben

REBOSADERO
TROP PLEIN
OVERFLOW
TROPPOPIENO
ÜBERLAUF

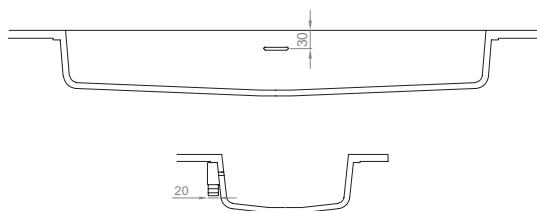

Seno XL85 · Vasque XL85 · XL85 washbasin · Lavabo XL85 · Becken XL85

OTROS
AUTRES
OTHERS
ALTRE
ANDERE

Distancias mínimas · Distances minimales · Minimum distances · Distanze minime · Mindestabstände

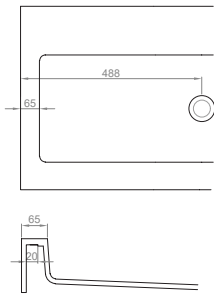

Sin toallero
Sans porteserviette
Without towel rack
Senza portasciugamani
Ohne Handtuchhalter

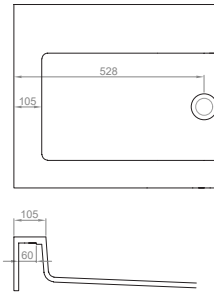

Con toallero
Avec porteserviette
With towel rack
Con portasciugamani
Mit Handtuchhalter

Tamaños mínimos · Dimensions minimales · Minimum sizes · Dimensione minime · Mindestgrößen

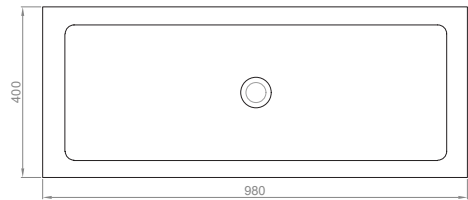
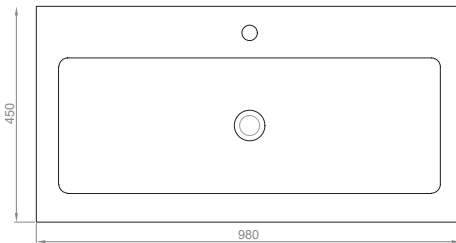

SOPORTES
SUPPORTS
WALL ANCHORS
STAFFE
WANDHALTERUNGEN

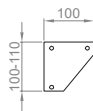
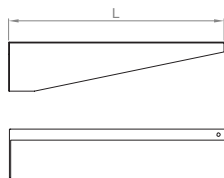

Acero galvanizado lacado
Acier galvanisé laqué
Lacquered galvanised steel
Acciaio zincato laccato
Lackierter verzinkter Stahl

Seno XL120 · Vasque XL120 · XL120 washbasin · Lavabo XL120 · Becken XL120

IMÁGEN
IMAGE
PICTURE
IMMAGINE
BILD

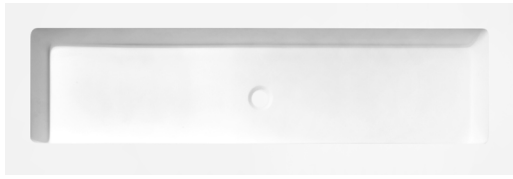

DIMENSIONES
DIMENSIONS
DIMENSIONS
DIMENSIONI
GRÖßE

Seno · Vasque · Washbasin · Lavabo · Becken

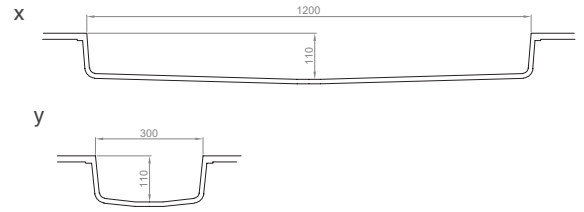
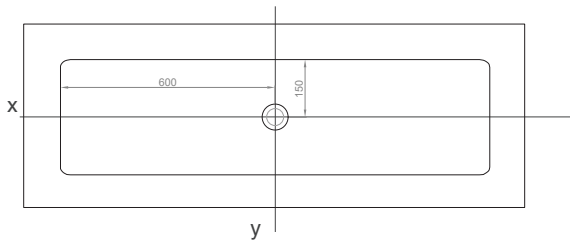

Encimera · Plan de vasque · Top · Waschtischplatte

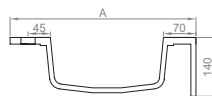
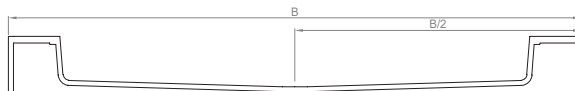
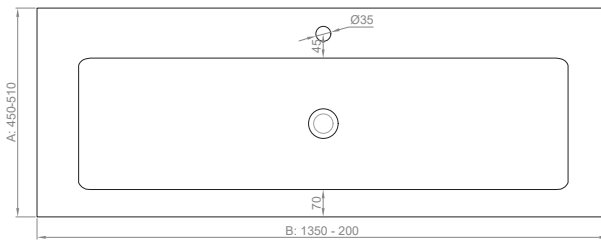

P = 44,6 kg/m²

Peso por m²
Poids par m²
Weight per m²
Peso per m²
Gewicht pro m²

V = (B+5)x55x20 cm³

Volumen en la caja
L: largo B: ancho
Volume dans la boîte
L: longueur B: largeur

P* = 49,6 kg/m²

Peso con embalaje
Poids avec emballage
Weight with packaging
Peso con imballaggio
Gewicht mit verpackung

Volumen in box
L: length B: width

Volumen nella scatola
L: lunghezza B: larghezza

Volumen in der Box
L: lang B: breitew

Posición del seno personalizable - Position de la vasque personnalisable - Customizable washbasin position - Posizione dei lavabi personalizzabile - Becken nach mass verschoben

REBOSADERO
TROP PLEIN
OVERFLOW
TROPPOPIENO
ÜBERLAUF

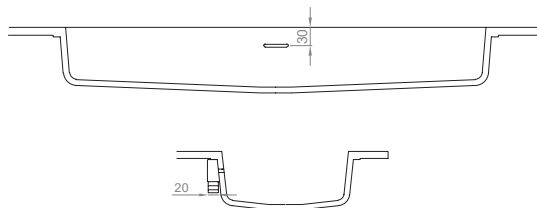

Seno XL120 · Vasque XL120 · XL120 washbasin · Lavabo XL120 · Becken XL120

OTROS
AUTRES
OTHERS
ALTRE
ANDERE

Distancias mínimas · Distances minimales · Minimum distances · Distanze minime · Mindestabstände

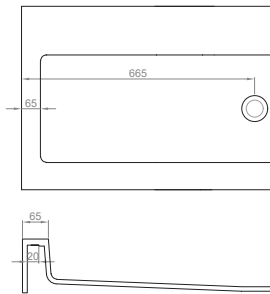

Sin toallero
Sans porteserviette
Without towel rack
Senza portasciugamani
Ohne Handtuchhalter

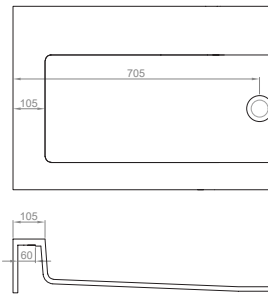

Con toallero
Avec porteserviette
With towel rack
Con portasciugamani
Mit Handtuchhalter

Tamaños mínimos · Dimensions minimales · Minimum sizes · Dimensione minime · Mindestgrößen

SOPORTES
SUPPORTS
WALL ANCHORS
STAFFE
WANDHALTERUNGEN

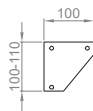
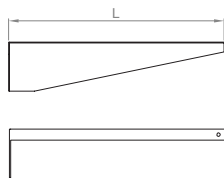

Acero galvanizado lacado
Acier galvanisé laqué
Lacquered galvanised steel
Acciaio zincato laccato
Lackierter verzinkter Stahl